

**FOCUSED  
ON YOUR  
SUCCESS.**

**EDEL**

**WERKZEUGMASCHINEN**

*Part of the GMTGroup*

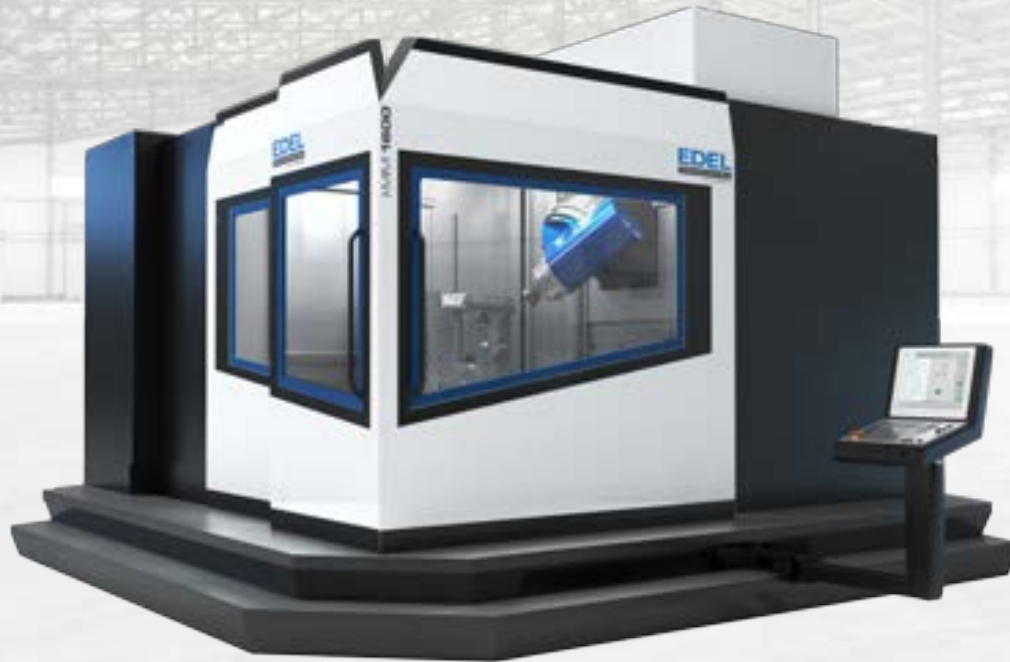

DE | EN

**> MACHINE  
OVERVIEW**

# TABLE OF CONTENTS

Making the CUT easily with EDEL. Comprehensive production know-how, highest precision and fast service. Universal **3-axis milling machines and 5/6-axis machining centers** with the highest quality outputs!

## 04

**GMTG** - Strong Group,  
strong partners

## 08

**Modularity**  
Countless variants

## 06

**Industry expertise**  
From Die & Mould to  
Aerospace

## 10

**Milling heads**  
Technical highlights

## 07

**EDEL**  
Product line

## 12

**Fork milling heads**  
Technical data

**13****Universal milling heads**

Technical data

**14****Performance charts**

&amp; Technical data

**16****(Swivel) rotary tables**

Technical highlights and data

**18****VERTIMILL**

series

**20****VERTIMILL U**

series

**22****CENTERMILL**

series

**26****MULTIMILL**

series

**30****ROTAMILL**

series

**32****TABLEMILL**

series

**34****CYPORT**

series

**36****Automation****38****Variety of options****39****DEPO**

Product line

# GMTG

German Machine Tool Group

## FOCUSED ON YOUR SUCCESS.

## FOCUSED ON YOU.

Our customers are more than just a number to us – we focus on you and your company. Whether drawing up the specifications of a custom machine just for you or creating a proactive service concept, we are always ready to actively support you as your partners.

**Get in touch now! We would be happy to advise you about your options at GMTG.**

- **You** – We will accompany you personally as your partners!
- **Your company** – Our objective: the most economically attractive solution for you!
- **Your productivity** – Our core competencies: machine & process optimization!
- **Our quality** – All core components from the same source! Made in Germany!
- **Our service** – On site with you at the earliest opportunity!
- **Our prices** – Fairly priced machines and services!

## OUR CLAIM? YOUR BENEFITS!

At GMTG you can order any of the products and services that you already know and love from DEPO and EDEL – from a single source – anywhere in the world! **With sales, services, and administration consolidated under the single roof of the German Machine Tool Group**, both companies are secure for the future. Stronger than ever, we are excited to deploy

our great innovative strength to become reliable and trustworthy partners for our customers. **Short sales and service response times and high spare parts availability** are our most important goals! In addition, our experts can actively support you with process and tool optimization.

# STRONG GROUP – STRONG PARTNERS.

The German Machine Tool Group –  
focused on your success.

The brand **German Machine Tool Group**, or **GMTG** for short, is nothing less than a top-performing association between the two family-owned German machine construction companies **EDEL Werkzeugmaschinen GmbH** and **DEPO Werkzeugmaschinen GmbH**.

Innovative **process and productivity know-how** meet more than 100 years of experience and highest-precision mechanical engineering – the product and service portfolios of DEPO Werkzeugmaschinen GmbH from Marienfeld in North Rhine-Westphalia and EDEL Werkzeugmaschinen GmbH from Pliezhausen in Baden-Württemberg complement one another perfectly. With almost **1,000 machines installed** at big-name customers with the highest quality standards from the **mould and die-making sector**, the **aerospace industry**, and the **automotive industry**, we draw from extensive experience across a diverse range of requirements.

High-productivity **vertical and horizontal 3/4** or universal **5/6-axis machining centers** to manufacture workpieces ranging from complex and delicate parts to heavy machining of high-strength materials are available from a single source. Our **modular machine design** gives customers maximum flexibility for their own individual configurations.

Thanks to a close technological partnership to develop core components such as milling heads, spindles, and rotary tables, we can now offer you **manufacturing solutions that are specially tailored to your requirements**, even beyond the usual standards. GMTG delivers machine tools whose components communicate perfectly, developed harmoniously.



## SHORT FACTS

- Family-owned company since **1989**
- **Automatic spindle change** available
- Strongly **modular machine design**
- New approaches to manufacturing technology
- **Vertical** and **horizontal** machining



## SHORT FACTS

- Family-owned company since **1896**
- **Crane hook machines:** rapid installation and machine relocation
- **Automatic head exchange** feature
- Extensions for **up to 7 axes**

# DEPO

WERKZEUGMASCHINEN

Part of the GMTGroup

# EDEL

WERKZEUGMASCHINEN

Part of the GMTGroup



# OUR INDUSTRY KNOW-HOW

Your application – our experience

Thanks to **decades of experience** in the capital goods industry and various industrial sectors, **EDEL Werkzeugmaschinen GmbH** is able to supply tailor-made and **customer-oriented** solutions.

Our machines are especially used in the **Die & Mold** and **Aerospace** industries. They are convincing due to **long time accuracies** and **process securities**.

Automotive

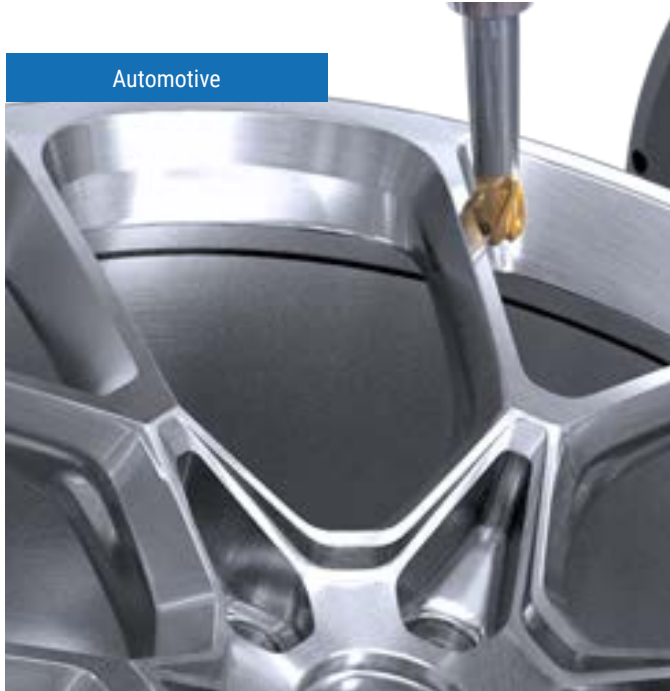

Energy



Machine construction



Aerospace



Die & Mould

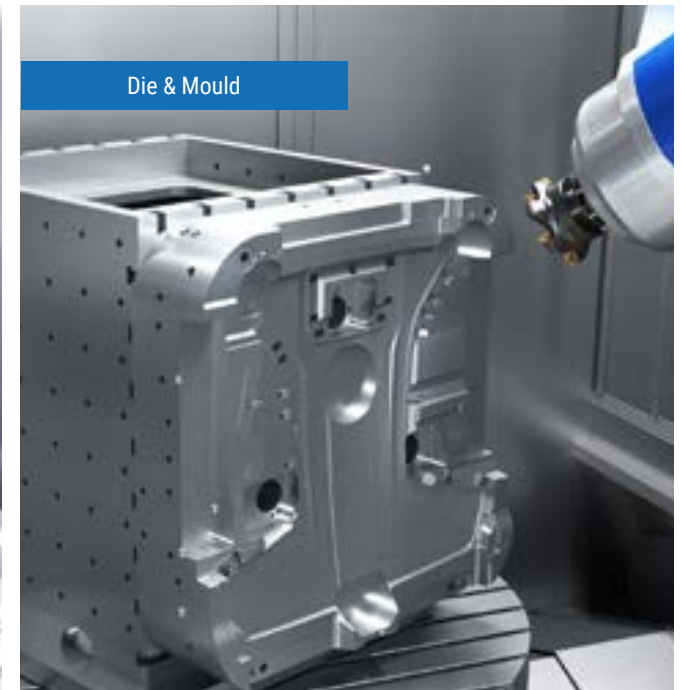

# OUR PRODUCT- PORTFOLIO

## Highly productive 5/6 axis machining centers

We have been consistently and strategically expanding our product portfolio ever since our company was founded. We are always working to ensure that our machines have every characteristic property of our brand and market segment that our customers have come to know, value, and expect. We attach **great importance** to:

- Rigidity and durable machine design
- Large and organized workspaces with compact layouts
- Excellent transportability thanks to the crane hook design
- Individuality and flexibility in machine configuration

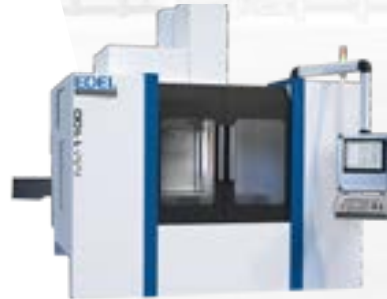

VERTIMILL



ROTAMILL



MULTIMILL

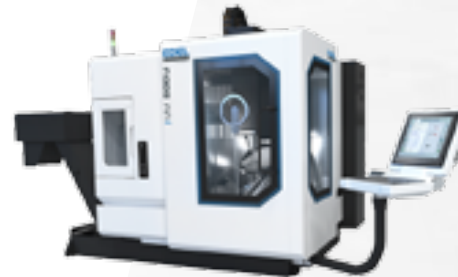

VERTIMILL U



CENTERMILL

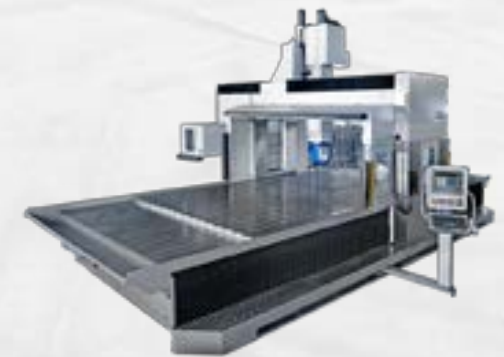

CYPOR



TABLEMILL

# PERFECTION PLUS MODULARITY.

Which machine is compatible with which milling head and which spindle? Use our modularity matrix and find your optimum machine configuration.



Full-featured 5-axis simultaneous machining



VERTIMILL series



VM 500 U



CENTERMILL series

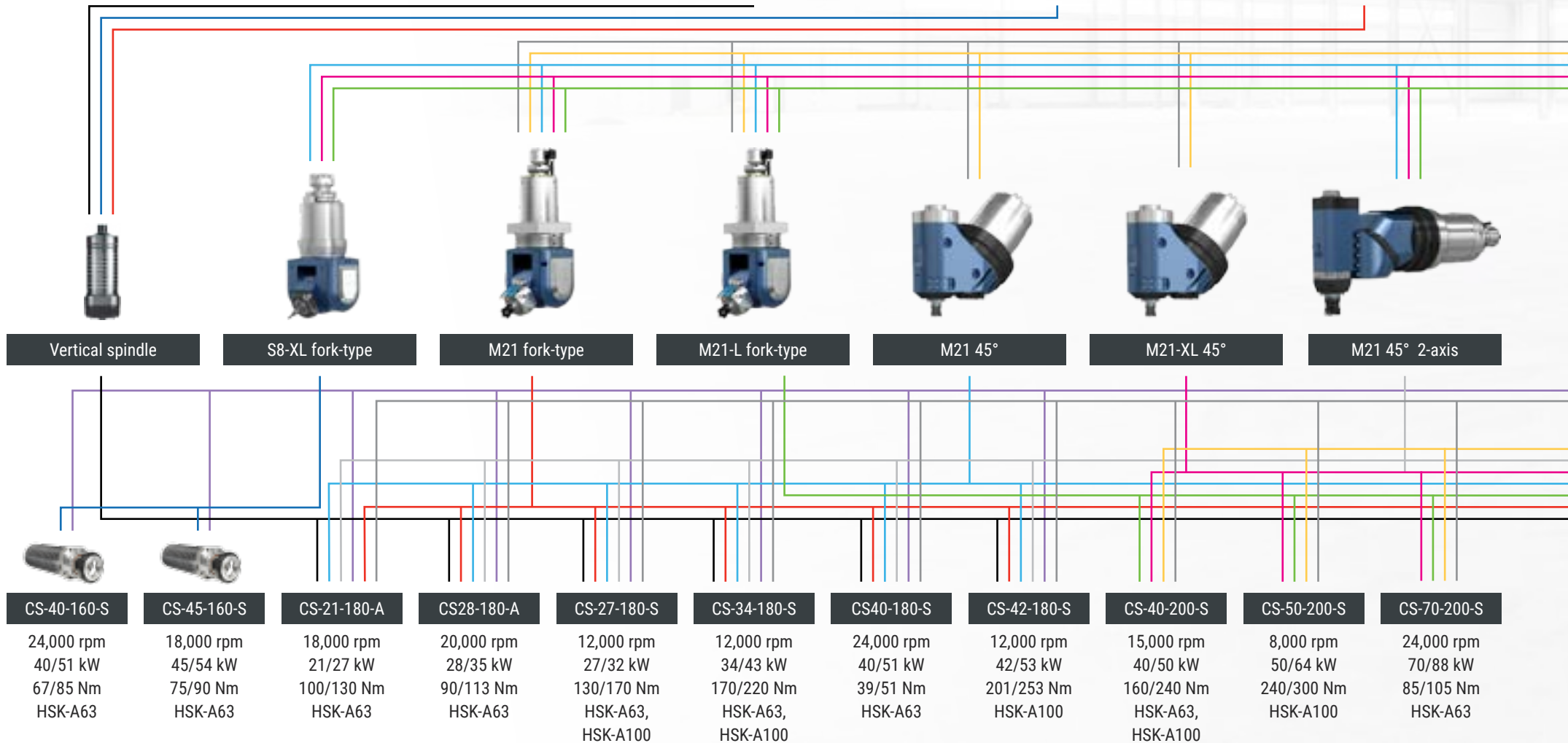

CS-40-160-S

24,000 rpm  
40/51 kW  
67/85 Nm  
HSK-A63

CS-45-160-S

18,000 rpm  
45/54 kW  
75/90 Nm  
HSK-A63

CS-21-180-A

18,000 rpm  
21/27 kW  
100/130 Nm  
HSK-A63

CS28-180-A

20,000 rpm  
28/35 kW  
90/113 Nm  
HSK-A63

CS-27-180-S

12,000 rpm  
27/32 kW  
130/170 Nm  
HSK-A63,  
HSK-A100

CS-34-180-S

12,000 rpm  
34/43 kW  
170/220 Nm  
HSK-A63,  
HSK-A100

CS40-180-S

24,000 rpm  
40/51 kW  
39/51 Nm  
HSK-A63

CS-42-180-S

12,000 rpm  
42/53 kW  
201/253 Nm  
HSK-A100

CS-40-200-S

15,000 rpm  
40/50 kW  
160/240 Nm  
HSK-A63,  
HSK-A100

CS-50-200-S

8,000 rpm  
50/64 kW  
240/300 Nm  
HSK-A100

CS-70-200-S

24,000 rpm  
70/88 kW  
85/105 Nm  
HSK-A63



Explanations: Spindle designation „CS“: motor spindle; „CST“: motor spindle with Hirth clamping for Mill-Turn functionality, max. speeds may be limited; „CSG“: gear box spindle; further tool tapers available on individual request.

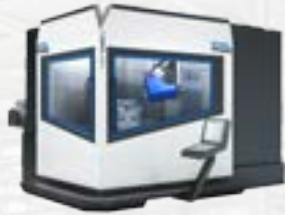

MM 1000 / MM 1000 XL



MM 1600



TABLEMILL series



ROTAMILL series



CYPORT series



M21-XL 45° 2-axis



G30 fork-type



G30 45°



T75S fork-type



M21 fork-type 140°



Orthogonal P12 2-axis

CS-50-238-A

15,000 rpm  
50/63 kW  
248 / 315 Nm  
HSK-A100,  
SK50

CS-42-238-S

8,000 rpm  
42/55 kW  
400/525 Nm  
HSK-A100

CS-70-238-S

22,000 rpm  
70/90 kW  
85/105 Nm  
HSK-A63,  
SK 50

CS-75-260A

10,000 rpm  
75/94 kW  
484/620 Nm  
HSK-A100,  
SK50

CS-110-260-S

5,000 rpm  
110/138 kW  
650/824 Nm  
HSK-A100,  
SK 50

CST-27-180-S

10,000 rpm  
27/32 kW  
130/170 Nm  
HSK-T63  
Mill-Turn

CST-34-180-S

10,000 rpm  
34/43 kW  
170/220 Nm  
HSK-T63,  
HSK-T100  
Mill-Turn

CST-42-180-S

10,000 rpm  
42/53 kW  
201/253 Nm  
HSK-T100  
Mill-Turn

CST-50-200-S

10,000 rpm  
50/64 kW  
240/300 Nm  
HSK-T100  
Mill-Turn

CST-42-238-S

8,000 rpm  
42/55 kW  
400/525 Nm  
HSK-T100  
Mill-Turn

CSG-50-300-S

7,000 rpm  
50/65 kW  
795/1,022 Nm  
HSK-A100  
Gearbox



# MILLING HEADS

Our decades of experience in the development of **milling heads with torque motors** offer an immense **advantage in performance and dynamics**. Excellent acceleration values and highly accurate positioning capability provide the best conditions for optimum machining results. The effective **cooling concept in the swivel axes** as well as the powerful hydraulic clamping ensure a **long service life even under high demand** in heavy-duty machining.

## Milling heads in different configurations

- matched to the selected machine type
- single and multi-axis systems
- **fork, universal and orthogonal versions**

## Maximum precision

- radial/axial roller bearings pre-tensioned without clearance (3)
- state-of-the-art **measuring systems**
- high torsional stiffness

## Built-in safety package

in the form of overall sensor technology for monitoring all function values throughout the machining process.

## High flexural system stiffness as a result of thorough FEM calculations

- **Simulation of different demand situations** through different loads and machining processes
- optimized, **weight-reduced construction**

## Water-cooled UltraHighTorque direct drives (1)

- for maximized performance and dynamics
- effective **cooling concepts** in A- /C-axis
- powerful **hydraulic clamping** (2)



## Full-featured simultaneous machining

### Sealed axle housings

and sealing hoods on the axial sections provide reliable protection against harmful environmental influences and dirt

### Intelligent supply / data transmission concept

- through a sophisticated internal arrangement with flexible wiring/piping
- **Direct measuring measuring systems** (rotary encoders) in all axes
- **Water cooling (4)**



### High-precision sensor technology for maximum accuracy

- Spindle growth (SGS)
- Vibration (SVS)
- Temperature (STS)
- etc.

### Standard and optional main spindles for a wide range of requirements

- **Direct drive** via integrated torque motor (1)
- **Water Cooling**
- Various **tool interfaces** can be selected
- **Internal coolant supply** optional
- External coolant supply via **spray nozzles** on spindle nose

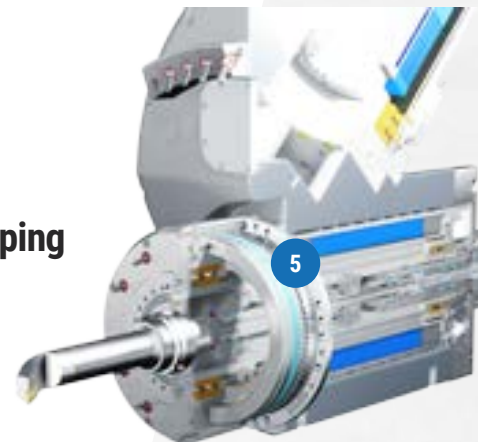

### Mill-Turn functionality with Hirth clamping

- Hydraulic clamping of the spindle shaft with Hirth lock (5)
- no pressure on sensitive spindle components



# FORK MILLING HEADS

## Technical Data

### S8 XL series

	A-AXIS	C-AXIS
Nominal- / Max. Torque [Nm]	630/1,190	670/1,320
Rated current [A]	27	15
Clamping torque at 60 bar [Nm]	2,400	2,400
Swivel range [°]	±110	±360
Measuring system	absolute	absolute
Positioning accuracy ["]	±5	±2
Total weight approx. [kg]	510	

### M21 series

	A-AXIS	C-AXIS
Nominal- / Max. Torque [Nm]	840/1,340	1,020/1,960
Rated current [A]	30	30
Clamping torque at 60 bar [Nm]	4,000	4,000
Swivel range [°]	±115	±360
Measuring system	absolute	absolute
Positioning accuracy ["]	±5	±2
Total weight approx. [kg]	860	

### M21-L series

	A-AXIS	C-AXIS
Nominal- / Max. Torque [Nm]	840/1,340	1,020/1,960
Rated current [A]	30	30
Clamping torque at 60 bar [Nm]	4,000	4,000
Swivel range [°]	±110	±360
Measuring system	absolute	absolute
Positioning accuracy ["]	±5	±2
Total weight approx. [kg]	960	

### M21 140° series

	A-AXIS	C-AXIS
Nominal- / Max. Torque [Nm]	840/1,340	1,020/1,960
Rated current [A]	30	30
Clamping torque at 60 bar [Nm]	4,000	4,000
Swivel range [°]	-120 / +140	±360
Measuring system	absolute	absolute
Positioning accuracy ["]	±5	±2
Total weight approx. [kg]	950	

### G30 series

	A-AXIS	C-AXIS
Nominal- / Max. Torque [Nm]	2,000/3,700	1,830/3,550
Rated current [A]	30	29
Clamping torque at 60 bar [Nm]	7,000	7,000
Swivel range [°]	±110	±360
Measuring system	absolute	absolute
Positioning accuracy ["]	±2.5	±2
Total weight approx. [kg]	1,200	

### T75S series

	A-AXIS
Nominal- / Max. Torque [Nm]	2,400/4,400
Rated current [A]	56
Clamping torque at 60 bar [Nm]	6,200
Swivel range [°]	-55 / +135
Measuring system	absolute
Positioning accuracy ["]	2.5
Total weight approx. [kg]	1,650



# UNIVERSAL MILLING HEADS

## Technical Data

### M21 single-axis series

	B-AXIS
Nominal- / Max. Torque [Nm]	900/1,680
Rated current [A]	30
Clamping torque at 60 bar [Nm]	4,000
Swivel range [°]	-10 / +190
Measuring system	absolute
Positioning accuracy ["]	±2
Total weight approx. [kg]	410

### M21 XL single-axis series

	B-AXIS
Nominal- / Max. Torque [Nm]	780/1,470
Rated current [A]	30
Clamping torque at 60 bar [Nm]	2,500
Swivel range [°]	-10 / +190
Measuring system	absolute
Positioning accuracy ["]	±2
Total weight approx. [kg]	840

### G30 45° series

	B-AXIS
Nominal- / Max. Torque [Nm]	980 / 1830
Rated current [A]	30
Clamping torque at 60 bar [Nm]	4,000
Swivel range [°]	-10 / 190
Measuring system	absolute
Positioning accuracy ["]	±2
Total weight approx. [kg]	740



# PERFORMANCE CHARTS & TECHNICAL DATA

## CS-21-180-A

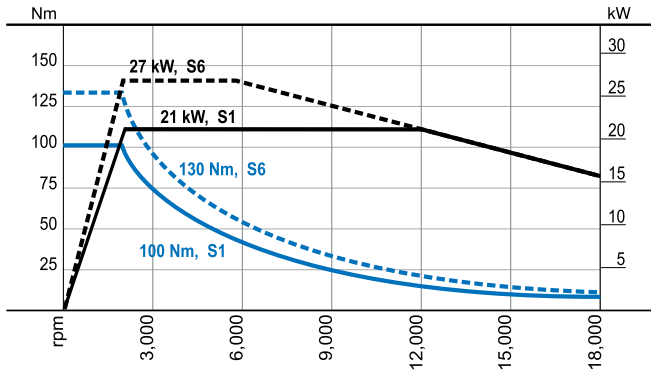

### TECHNICAL DATA

Speed, max.	18,000 rpm
Power	21 kW (S1), 27 kW (S6)
Torque, max.	100 Nm (S1), 130 Nm (S6)
Tool taper	HSK-A63

## CS-27-180-S/CST-27-180-S

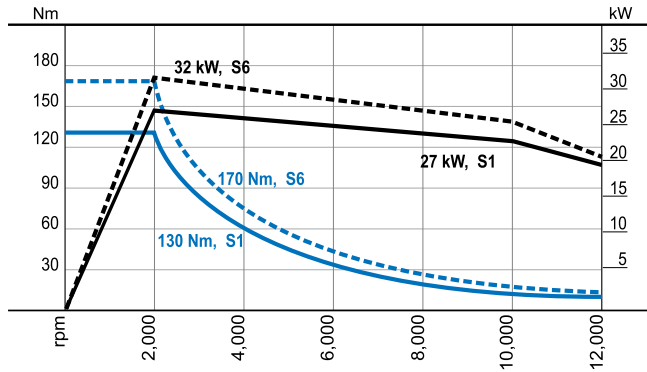

### TECHNICAL DATA

Speed, max.	12,000 rpm
Power	27 kW (S1), 32 kW (S6)
Torque, max.	130 Nm (S1), 170 Nm (S6)
Tool taper	HSK-A(T)63, HSK-A(T)100

## CS-34-180-A

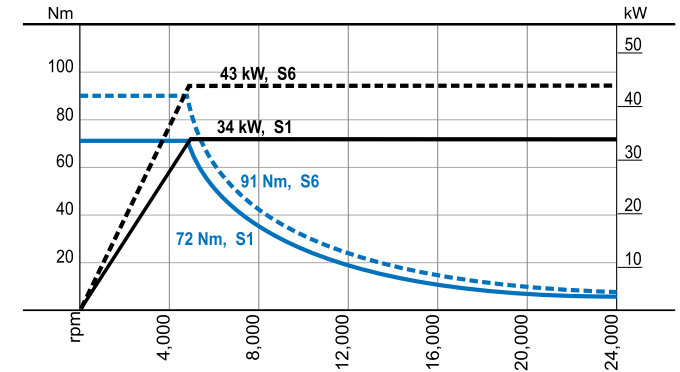

### TECHNICAL DATA

Speed, max.	24,000 rpm
Power	34 kW (S1), 43 kW (S6)
Torque, max.	72 Nm (S1), 91 Nm (S6)
Tool taper	HSK-A63

## CS-40-180-S

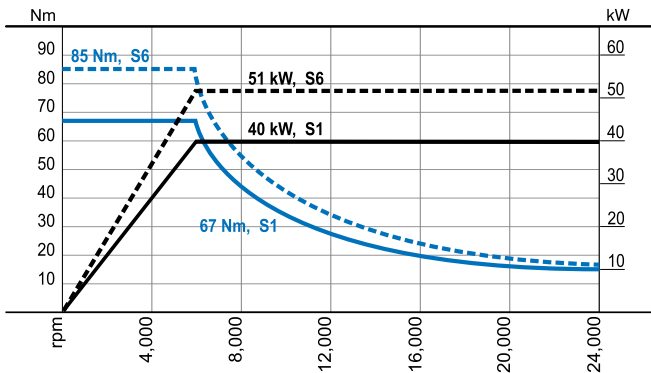

### TECHNICAL DATA

Speed, max.	24,000 rpm
Power	40 kW (S1), 51 kW (S6)
Torque, max.	39 Nm (S1), 51 Nm (S6)
Tool taper	HSK-A63

## CS-42-180-S/CST-42-180-S

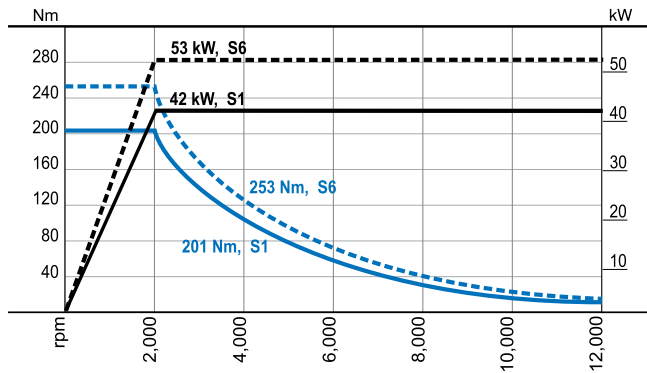

### TECHNICAL DATA

Speed, max.	12,000 rpm
Power	42 kW (S1), 53 kW (S6)
Torque, max.	201 Nm (S1), 253 Nm (S6)
Tool taper	HSK-A(T)63, HSK-A(T)100

## CS-40-200-S

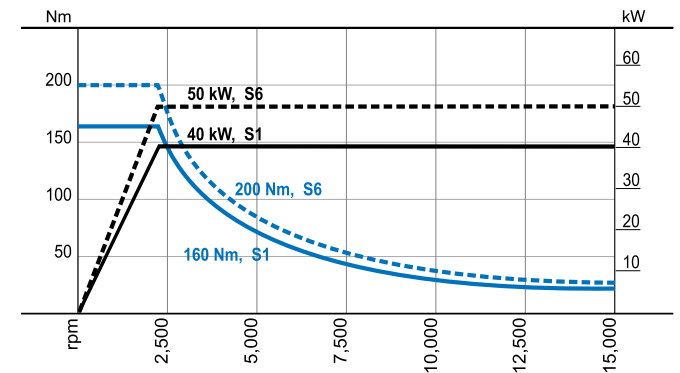

### TECHNICAL DATA

Speed, max.	15,000 rpm
Power	40 kW (S1), 50 kW (S6)
Torque, max.	160 Nm (S1), 240 Nm (S6)
Tool taper	HSK-A63, HSK-A100

Explanations: Spindle designation „CS“: motor spindle; „CST“: motor spindle with Hirth clamping for Mill-Turn functionality, max. speeds may be limited; „CSG“: gear box spindle; further tool tapers available on individual request.

### CS-50-200-S/CST-50-200-S

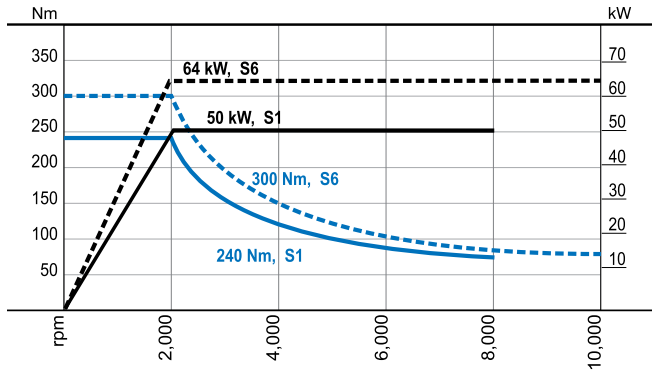

TECHNICAL DATA	
Speed, max.	8,000 rpm
Power	50 kW (S1), 64 kW (S6)
Torque, max.	240 Nm (S1), 300 Nm (S6)
Tool taper	HSK-A(T)100

### CS-70-200-S

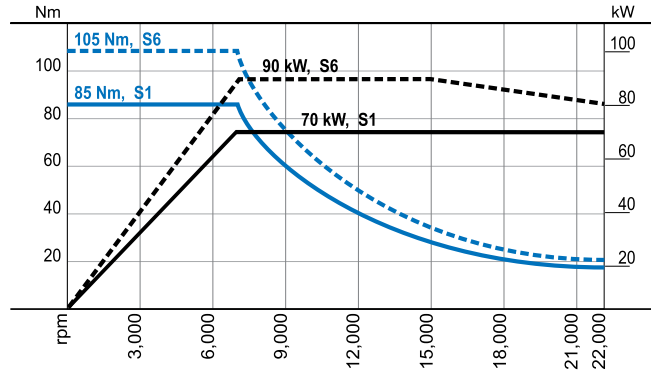

TECHNICAL DATA	
Speed, max.	24,000 rpm
Power	70 kW (S1), 88 kW (S6)
Torque, max.	85 Nm (S1), 105 Nm (S6)
Tool taper	HSK-A63

### CS-42-238-S/CST-42-238-S

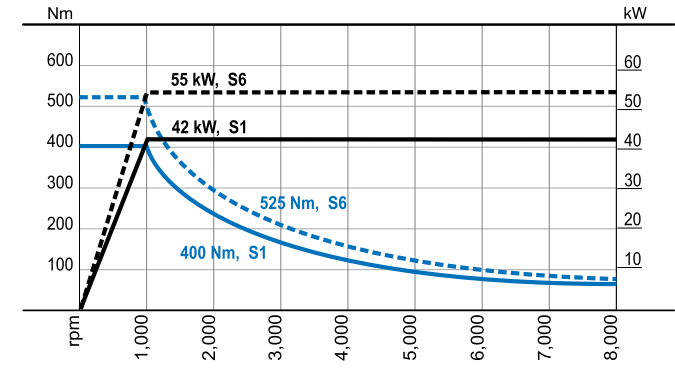

TECHNICAL DATA	
Speed, max.	8,000 rpm
Power	42 kW (S1), 55 kW (S6)
Torque, max.	400 Nm (S1), 525 Nm (S6)
Tool taper	HSK-A(T)100, SK 50

### CS-50-238-A

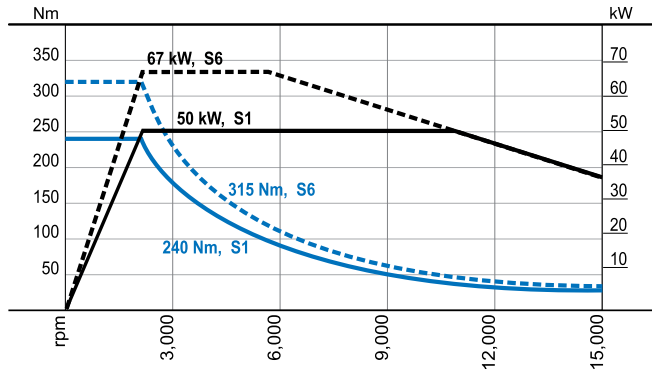

TECHNICAL DATA	
Speed, max.	15,000 rpm
Power	50 kW (S1), 63 kW (S6)
Torque, max.	248 Nm (S1), 315 Nm (S6)
Tool taper	HSK-A100, SK50

### CS-110-260-S

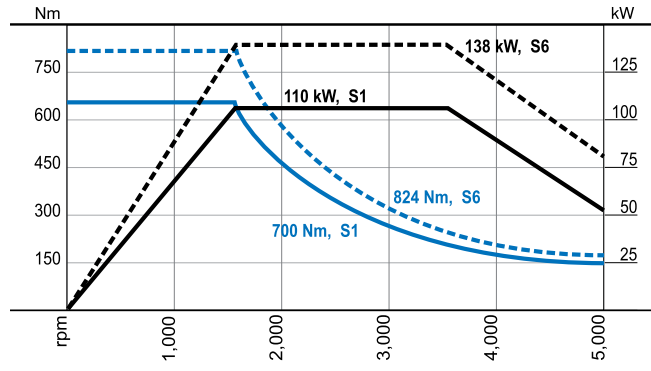

TECHNICAL DATA	
Speed, max.	5,000 rpm
Power	110 kW (S1), 138 kW (S6)
Torque, max.	650 Nm (S1), 824 Nm (S6)
Tool taper	HSK-A100, SK 50

### CSG-50-300-S - Geared spindle

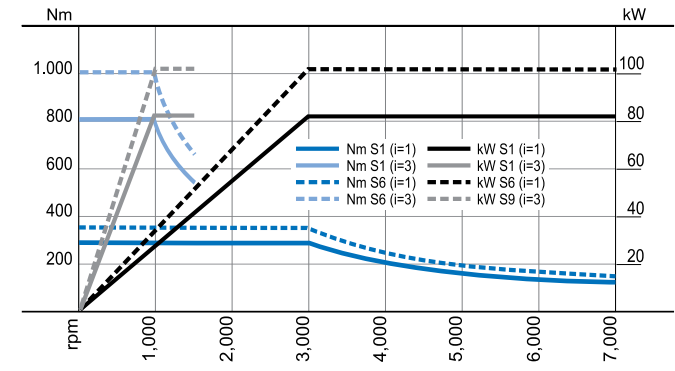

TECHNICAL DATA	
Speed, max.	7,000 rpm
Power	50 kW (S1), 65 kW (S6)
Torque, max.	S1: 265 Nm (i=1), 795 Nm (i=3); S6: 334 Nm (i=1), 1,022 Nm (i=3)
Tool taper	HSK-A100

# TABLE TECHNOLOGY

The configuration of our tables as workpiece holders is as modular as our milling head and spindle technology. Most of our machines are enabled for **5-axis simultaneous machining** by means of additional axes in the table. Our portfolio ranges from **highly dynamic rotary tables with up to 1,000 rpm** for milling and turning machining to tables with a permissible **total load of more than 90 tons!**

## Highlights (swivel) rotary tables

- **Highly dynamic torque drives enable high acceleration and extremely fast positioning**
- Intelligent **water cooling**
- **Mill-Turn** technology with **up to 1,000 rpm** is an option
- High **workpiece weights**
- Integrated hydraulic clamping device for **heavy-duty machining**
- **Up to 2,500 mm diameter**
- **Direct measuring systems** by absolute encoders
- Optional **zero point clamping system** integrated into the tabletop
- Customizable groove and hole pattern to suit customer requirements



Integrated monitoring/  
safety package

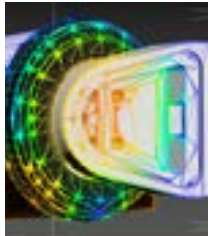

Overall structure  
FEM-optimized

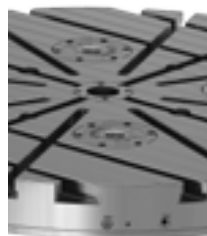

Option: Integrated zero  
point- / pallet clamps

## Highlights of rigid machine tables

- For workpieces with lengths of **more than 11 meters**
- Table loads of up to **98 tons max.**
- Optional **zero point clamping system** integrated into the tabletop
- Customizable groove and hole pattern to suit customer requirements
- Additional **attachment axes** optionally
- Optional **integrated rotary table** in the tabletop

# NC ROTARY TABLES

Option of 5<sup>th</sup> axis for full **5-axis simultaneous machining** or as **6<sup>th</sup> axis** for positioning of the workpiece add-on: **Productivity increase!** with the **direct-drive** rotary tables (C-axis) of the MULTIMILL and ROTAMILL series. When the turning technology package is selected, the machines can be configured as **Mill-Turn centers**.

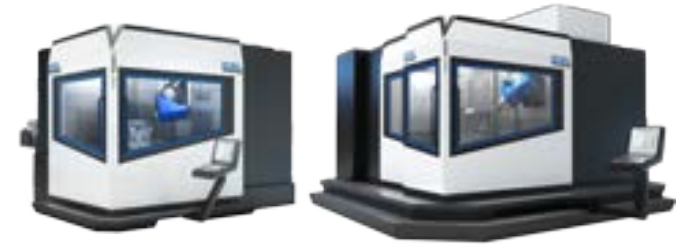

TECHNICAL DATA		MM 1000 / MM 1000 XL		MM 1600	
		MILLING	MILL-TURN	MILLING	MILL-TURN
Clamping surface	mm	1,000 x 800	Ø 900	Ø 1,320	Ø 1,320
Table load, max. centric	kg	2,000	1,000*	4,000	2,000*
Torque, nominal/max.	Nm	1,280 / 2,390	1,127 / 2,065	2,830 / 5,235	2,583 / 4,540
Speed, max.	rpm	95	800	80	450
Clamping torque	Nm	4,000	4,000	10,000	10,000
Positioning accuracy	arcsec	±5	±5	±2	±2

TECHNICAL DATA		ROTAMILL SERIES	
		MILLING	MILL-TURN
Clamping surface, standard	mm	Ø 1,800	Ø 1,800
Clamping surface, optional	mm	Ø 1,500, Ø 1,200	Ø 1,500, Ø 1,200
Table load, max. centric	kg	6,000	2,000*
Torque, nominal/max.	Nm	7,473 / 13,909	7,051 / 12,115
Speed, max.	rpm	40	300
Clamping torque	Nm	13,000	13,000
Positioning accuracy	arcsec	±2	±2



## High-tech integrated

- Wear-resistant gearless **direct drives** with torque motors
- **Integrated clamping function** thanks to hydraulically operated expansion sleeves, e.g. for rough cutting tasks
- **High bearing rigidity** of the work holding plate due to play-free pre-tensioned axial radial bearings
- **Integrated water cooling**



\*) maximum table load during turning. For milling, the values specified in the „Milling“ column apply



## 2-AXIS SWIVEL ROTARY TABLES

We expect the highest level of quality and dynamics with **the 2-axis swivel rotary tables** of our CENTERMILL series and the VM 500 U. Our best equipment version can achieve the highest accele-

ration values, with **double-sided torque direct drive** (standard CM 800). **Speeds of up to 1,000 rpm** in the C-axis open up a whole new range of **turning functionality on a milling machine**.



TECHNICAL DATA		VM 500 U **	CM 400		CM 800	
		MILLING	MILLING	MILL-TURN	MILLING	MILL-TURN
Clamping surface	mm	Ø 630 x 500	Ø 400 x 550	Ø 400 x 550	Ø 800	Ø 1,320
Swivel range A-axis	°	-5 - +110	-42 - +120	-42 - +120	±120	±120
Swivel range C-axis	°	360	360	360	360	360
Table load, max.	kg	250	500	300*	1,000	500*
Torque A-axis, nominal/max.	Nm	726 / 2,662	1,400 / 2,650	1,400 / 2,650	2,980 / 4,780	2,980 / 4,780
Torque C-axis, nominal/max.	Nm	440 / 879	310 / 600	280 / 500	1,180 / 1,930	800 / 1,150
Speed C-axis, max.	rpm	20	195	600	105	1,000
Speed A-axis, max.	rpm	20	80	80	80	80
Clamping torque A-axis	Nm	2,130	4,000	4,000	5,640	5,640
Clamping torque C-axis	Nm	703	1,600	1,600	2.800	2.800
Positioning accuracy	"	±7	±5 / ±2	±5 / ±2	±5	±5

\*\* ) for VM 500 U, the second swivel axis is referred to as the B-axis instead of the A-axis.

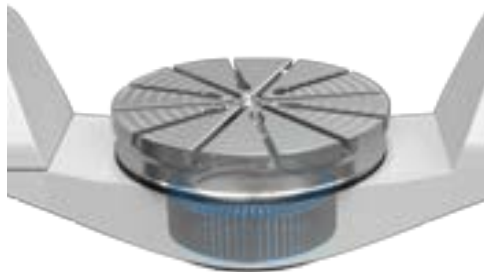

2-axis swivel rotary table of CM 800



2-axis swivel rotary table of VM 500 U

## RIGID MACHINE TABLES

The VERTIMILL, TABLEMILL and CYPOR machines have **rigid tables**. Of course, both machine series can be equipped with **additional attachment axes**.

Plus, **rotary tables with of up to Ø 2,500 mm** can be integrated into the table top of the CYPOR machines.



MACHINE	CLAMPING SURFACE [MM]	MAX. TABLE LOAD [KG]	SLOT PATTERN [MM]
<b>VERTIMILL</b>			
VM 760	900 x 420	350	14 x 3 x 125
VM 900	1,060 x 600	650	18 x 5 x 100
VM 1100	1,300 x 600	800	18 x 5 x 100
VM 1300	1,500 x 650	1,000	18 x 5 x 100
<b>TABLEMILL</b>			
TM 2413	2,500 x 1,400	14,000	Individual
TM 3620	3,700 x 2,100	31,000	Individual
TM 4820	4,900 x 2,100	41,000	Individual

MACHINE	CLAMPING SURFACE [MM]	MAX. TABLE LOAD [KG]	TABLETOP SURFACE [MM]
<b>CYPOR</b>			
CP 3020	3,100 x 2,100	26,000	5,000 x 2,310
CP 4020	4,000 x 2,100	33,600	6,250 x 2,310
CP 5020	5,000 x 2,100	42,000	7,480 x 2,310
CP 4030	4,000 x 3,100	49,600	6,250 x 2,310
CP 5030	5,200 x 3,100	64,400	7,480 x 3,310
CP 6030	6,100 x 3,100	76,800	8,700 x 3,310
CP 7030	7,200 x 3,100	89,000	10,000 x 3,310
CP 8030	8,100 x 3,100	98,000	11,100 x 3,310

# VERTIMILL SERIES

Robust and dynamic at the same time – our 3-axis milling machines with a table load capacity of up to 1,000 kg.

› VM 760

› VM 900

› VM 1100

› VM 1300

Our vertical milling machines are convincing with their **robust machine design** due to a detailed FEM analysis. The resulting stiffness and particularly wide machine stands ensure **reduced vibrations and the best machining results**. The concept is rounded out with a universal motor spindle as well as high acceleration values and speeds for greater productivity. Durability and highest accuracy are achieved by pre-tensioned ball screws of the highest quality. The machines of the VERTIMILL series come with excellent equipment as a standard.

## VERTIMILL standard equipment

- Siemens 840 D with 15" display
- CYTEC HSK-A63 motor spindle with 18,000 rpm, 130 Nm and 27 kW (S6)
- Tool magazine with 24 pockets
- Loading door for direct loading of the magazine
- Electronic handwheel
- Full enclosure
- Signal light
- Flushing gun and coolant tank
- Workspace flushing
- Chip conveyor

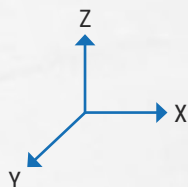

# EQUIPMENT & VARIANTS

We look for the highest possible **quality and durability** when selecting our components. Our main goal is **to increase our customers' productivity** and to maintain it at all times. That is why we pay

attention to perfectly matched components already during machine design and select our suppliers carefully.

COMPONENTS MANUFACTURERS	
Axle drives	SIEMENS
Direct measuring system	HEIDENHAIN
Ball screws	NSK
Linear guides	INA Schaeffler
Spindle	CYTEC
Control	SIEMENS
Safety relay	SKF

All machines in the VERTIMILL series can be equipped with additional swivel tables and upgraded to **4/5-axis machining**. Our technology partners CYTEC and FTW offer a broad portfolio of available additional axes.

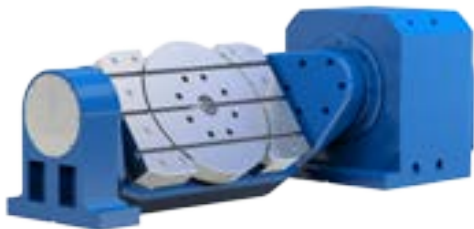

Our VERTIMILL series offers a **wide range of control providers**. In addition to the standard SIEMENS controls, you have the option of controlling the machines using FANUC or HEIDENHAIN.



# TECHNICAL DATA

		VM 760	VM 900	VM 1100	VM 1300
<b>WORKING AREA</b>					
Travel range X	mm	760	900	1,100	1,300
Travel range Y	mm	450	600	650	650
Travel range Z	mm	520	600	600	600
Spindle nose distance - machine table (vertical)	mm	100 - 620	150 - 750	150 - 750	150 - 750
Rapid traverse	m/min	48		36	
Feed rate	m/min	12		12	
Table load, max.	kg	350	650	800	1,000
<b>CONTROL</b>					
SIEMENS 840D (optional HEIDENHAIN TNC 640)					
<b>MAIN SPINDLE (STANDARD)</b>					
Tool taper				HSK-A63	
Speed, max.	rpm			18,000	
Power S1/S6	kW			21 / 27 kW	
Torque, max. S1/S6	Nm			100 / 130 Nm	
<b>ACCURACY ACCORDING TO VDI / DGQ 3441</b>					
Positioning accuracy X/Y/Z no dir. Measuring system	mm		± 0.010		± 0.012
Positioning accuracy X/Y/Z with dir. Measuring system	mm		± 0.006		± 0.008
Repeatability X/Y/Z no dir. Measuring system	mm		± 0.006		± 0.008
Repeatability X/Y/Z with dir. measuring system	mm		± 0.004		± 0.006
<b>WERKZEUGMAGAZIN (STANDARD)</b>					
No of tools				24	
Tool weight, max.	kg			8	
Tool length, max.	mm			300	
Tool-Ø, max.	mm			78	
Tool-Ø, max.	mm			125 (if adjacent slots empty)	
<b>INSTALLATION DATA</b>					
Installation dimension X	mm	2,400	2,800	2,930	3,150
Installation dimension Y	mm	2,210	2,345	2,250	3,100
Installation dimension Z	mm	2,900	3,000	3,150	3,150
Installation X/Y/Z	mm		3,500/2,270/2,800		
Weight	kg	4,500	6,000	7,500	7,800

# VERTIMILL U SERIES

Full-featured 5-axis simultaneous machining for higher productivity.

## > VM 500 U

The **VM 500 U** of the **VERTIMILL U series** is characterized by its flexibility and compactness. Full-featured **5-axis simultaneous machining** is possible thanks to the NC swivel rotary table with **direct measuring system**. We can configure the machine according to your wishes and requirements due to numerous specification options. Our VM 500 U is already equipped in its standard version with everything you need for a direct start into 5-axis machining. Of course, you can still add a number of options.

### Standard equipment VM 500 U

- **Siemens 840 D** with ShopMill
- 19" display
- **Direct measuring system** from HEIDENHAIN
- **CYTEC HSK-A63 motor spindle with 18,000 rpm, 130 Nm and 27 kW (S6)**
- **NC swivel rotary table** for full 5-axis simultaneous machining (-5° to +110°)
- Tool magazine with **40 pockets**
- Loading door for direct loading of the magazine
- Electronic handwheel
- Full enclosure
- Active cooling unit for control cabinet
- Signal light
- Flushing gun and coolant tank

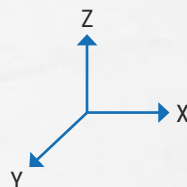
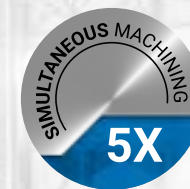



# AUTOMATION & VARIANTS

We look for the highest possible **quality and durability** when selecting our components. Our main goal is **to increase our customers' productivity** and to maintain it at all times. That is why we pay

attention to perfectly matched components already during machine design and select our suppliers carefully.

## COMPONENT MANUFACTURERS

Axle drives	SIEMENS
Direct measuring system	HEIDENHAIN
Hydraulics	HYDAC
Ball screws	KEMMLER
Linear guides	SCHNEEBERGER
Spindle	CYTEC
Control	SIEMENS
Central lubrication	SKF

## Highlights of NC swivel rotary table:

- Swivel range C-axis: 360°
- Swivel range B-axis: -5° to +110°
- Clamping surface: Ø 630 x 500 mm
- Max. loading weight: 250 kg
- Direct position measuring system (rotary encoder)
- Rotary passage for hydraulics and pneumatics
- High precision roller bearings in both axles



Option: Zero point clamping system (hydraulics or pneumatics)

# TECHNICAL DATA

<b>WORKING AREA</b>	
Travel ranges X / Y / Z	500 / 450 / 450 mm
Rapid traverse X / Y / Z	30 m/min
Feed force X / Y / Z	4,8 kN
<b>CNC CONTROL</b>	
SIEMENS	19" display: SINUMERIK 840D with ShopMill
<b>MAIN SPINDLE</b>	
Speed, max.	18,000 rpm
Power	21 / 27 kW (S1/S6)
Torque	100 / 130 Nm (S1/S6)
<b>SWIVEL ROTARY TABLE</b>	
Swivel range B- / C-axis	-5° to +110° / 360°
Swivel speed B- / C-axis	20 rpm
Clamping surface	Ø 630 x 500 mm
Table load, max.	250 kg
Clamping	Hydraulics
<b>ACCURACY ACCORDING TO VDI / DGQ 3441</b>	
Positioning accuracy X / Y / Z	0.008 mm
Positioning accuracy B / C	7"
Repeatability X / Y / Z	0.005 mm
Repeatability B / C	4"
<b>TOOL MAGAZINE</b>	
No of tools	40
Tool weight, max.	6 kg
Tool length, max.	300 mm
Tool diameter, max.	80 mm / 130 mm (for empty neighbouring spaces)
Chip-to-chip time (VDI 2852)	8 sec.
<b>INSTALLATION DATA</b>	
Machine weight	4,440 kg
Pre-fuse, max.	50A, 400 V
Power consumption	25 kVA – 28 kVA (with ICS)

# CENTERMILL SERIES

Perfect for your application, thanks to 2-axis swivel rotary table.

## CM 400

The 5-axis machining center CM 400 from the CENTERMILL series impresses with its **compact footprint and highly dynamic 5-axis simultaneous machining**, thanks to its swivel rotary table. The machine can be configured as Mill-Turn center, thus offering an even wider range of machining options. The FEM-analysed, strongly ribbed cast structure of the machine body ensures maximum vibration damping.

### Highlights of the standard version

- HEIDENHAIN TNC 640
- 5-axis simultaneous machining thanks to swivel rotary table (-42° to +120°)
- Highly dynamic thanks to torque drives
- Direct position measuring systems in all axes
- High-performance HSK-A63 motor spindle with 18,000 rpm, 130 Nm, 27 kW (S6)
- Tool magazine with 40 pockets HSK-A63
- Chip conveyor
- Ergonomic machine design
- Compact footprint

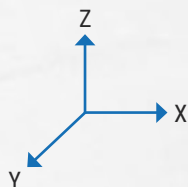
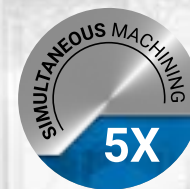

# EQUIPMENT & VARIANTS

The compactness of the CM 400 coupled with **high traversing speeds and excellent acceleration values** results in an immense **leap in productivity** for our customers. In combination with a **pallet changing system**, tailored to your requirements,

we enable you to take the next step toward nearly **unmanned production**. The **zero point clamping system**, which can be integrated into the **table-top**, ensures optimum use of the workspace with parallel automation.

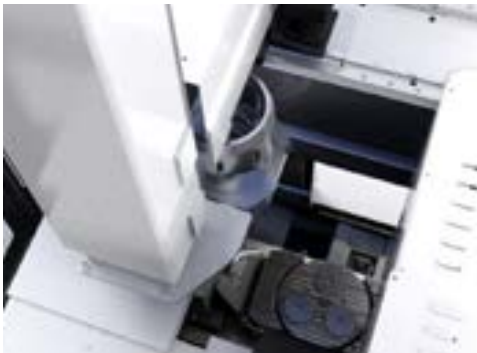

## ZERO POINT CLAMPING SYSTEM

Clamping force (at 35 bar) [kN]	30
Max. permissible clamping pressure [bar]	35
Max. permissible release pressure [bar]	40
Mass (incl. tightening bolts) [kg]	ca. 4.5

# TECHNICAL DATA

		Milling	Mill-Turn
<b>WORKING AREA</b>			
Travel range X / Y / Z	mm	800 / 610 / 510	
Rapid traverse X / Y / Z	m/min	36	
Acceleration X / Y / Z	m/s <sup>2</sup>	4	
<b>CONTROL</b>			
HEIDENHAIN TNC 640 (optional SIEMENS 840D)			
<b>MAIN SPINDLE (STANDARD)</b>			
Power S1/S6	kW	21 / 27	27 / 32
Torque S1/S6	Nm	100 / 130	130 / 170
Speed, max.	rpm	18,000	12,000
Tool taper		HSK-A63	HSK-T63
<b>SWIVEL ROTARY TABLE A- / C-AXIS</b>			
Clamping surface	mm	Ø 400 x 550	
Swivel range A-axis	°	-42 to +120	
Speed C-axis, max.	rpm	195	600
Loading weight, max.	kg	500	300
<b>ACCURACY ACCORDING TO VDI / DGQ 3441</b>			
Positioning accuracy X / Y / Z	mm	0.009	
Positioning accuracy A / C	"	±5	
Repeatability X / Y / Z	mm	0.007	
Repeatability A / C	"	±5	
<b>TOOL MAGAZINE (STANDARD)</b>			
No of tools		40	
Tool weight, max.	kg	8	
Tool length, max.	mm	300	
Tool-Ø, max.	mm	75	
Tool-Ø, max.	mm	150 (if adjacent slots empty)	
Tool taper		HSK-A63	HSK-T63
<b>INSTALLATION DATA</b>			
Space requirements X / Y	mm	3,150 / 2,250	
Machine height Z	mm	3,028	
Total weight	kg	7,800	

# CENTERMILL SERIES

Gantry design and 50 m/min rapid traverse!

## > CM 800

The **5-axis CM 800 machining center in gantry design** from the **CENTERMILL series** impresses with its enormous productivity. The double-sided torque drive of the swivel rotary table can achieve extremely high accelerations as well as high-precision positioning. The machine can be configured as **Mill-Turn center with up to 1,000 rpm**, thus offering an even wider range of machining options. The robust portal-type machine design ensures the best damping properties and optimum power transmission.

### Highlights of the standard version

- **HEIDENHAIN TNC 640**
- **5-axis simultaneous machining** thanks to swivel rotary table ( $\pm 120^\circ$ )
- **Strong dynamics** thanks to torque drives
- **50 m/min rapid traverse**
- **Direct position measuring systems** in all axes
- High-performance **HSK-A63 motor spindle** with **18,000 rpm, 130 Nm, 27 kW (S6)**
- **Tool magazine with 60 slots** HSK-A63
- **Chip conveyor**
- **Ergonomic machine design**

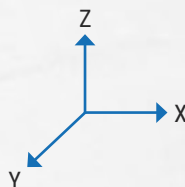
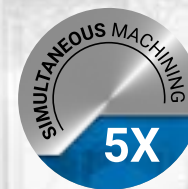



# STABILITY WITHOUT COMPROMISE

## Mill-Turn Technology

The highly dynamic rotary table with double-sided torque drive can be equipped with a **C-axis with a speed of up to 1,000 rpm** when the Turning Tech-

nology package is selected. **Milling and turning in one clamping** with constant positioning accuracy are no problem with the CM 800 MT.



## Stiffness and dynamics optimally complemented

The swivel rotary table, which is already taken into account in the basic machine design during development, optimally distributes the resulting forces to the surrounding cast-iron structure. **Best vibration damping properties** offer optimum conditions for **milling turning processes**. In addition, the design of the CM 800 impresses with its incredible **compactness**. The ratio of machine width (2,260 mm) to tabletop diameter (800 mm) is indicative of its **optimum space utilization**.



# TECHNICAL DATA

		Milling	Mill-Turn
<b>WORKING AREA</b>			
Travel range X / Y / Z	mm	800 / 900 / 620	
Spindle nose distance - machine table (vertical)	mm	100 / 720	
Rapid traverse X / Y / Z	m/min	50	
Feed rate X / Y / Z	m/min	50	
Feed force, max.	N	10,000	
<b>CONTROL</b>			
HEIDENHAIN TNC 640 (optional SIEMENS 840D)			
<b>MAIN SPINDLE (STANDARD)</b>			
Power S1/S6	kW	21 / 27	27 / 32
Torque S1/S6	Nm	100 / 130	130 / 170
Speed, max.	rpm	18,000	12,000
Tool taper		HSK-A63	HSK-T63
<b>SWIVEL ROTARY TABLE A- / C-AXIS</b>			
Clamping surface	mm	Ø 800	
Swing Ø (C-axis)	mm	1,000	
Workpiece height, max.	mm	600	
Speed C-axis, max.	rpm	105	1,000
Swivel range A-axis	°	± 120	
Loading weight, max.	kg	1,000	500
<b>ACCURACY ACCORDING TO VDI / DGQ 3441</b>			
Positioning accuracy X / Y / Z	mm	0.009	
Positioning accuracy A / C	"	±5	
Repeatability X / Y / Z	mm	0.007	
Repeatability A / C	"	±5	
<b>TOOL MAGAZINE (STANDARD)</b>			
No of tools		60	
Tool weight, max.	kg	8	
Tool length, max.	mm	300	
Tool Ø max.	mm	75	
Tool Ø max. if adjacent slots empty	mm	130	
<b>INSTALLATION DATA</b>			
Space requirements X / Y	mm	3,300 / 6,100	
Machine height Z	mm	3,950	
Total weight	kg	25,000	

# MULTIMILL SERIES

Universally applicable and highly productive.

› MM 1000

› MM 1000 XL

The universal **5-axis machining centers MM 1000 and MM 1000 XL** (extended Y travel path) of the **MULTIMILL series** are characterized by their highest stiffness and enable machining of **high-strength materials** as well as machining of **filigree component structures**. Both machines can be configured as **Mill-Turn centers** and offer extensive machining options at **speeds of up to 800 rpm**.

## Highlights of the standard version MM 1000 / MM 1000 XL

- HEIDENHAIN TNC 640
- **5-axis simultaneous machining** thanks to M21 45° swivel milling head
- **Highly dynamic** thanks to NC rotary table with torque drives and a **table size of Ø1,000 x 800 mm**
- **Direct position measuring systems** in all axes
- Powerful motor spindles with **12,000 rpm**
- Rapid traverse: **40 m/min**
- **Tool magazine with 52 / 60 pockets** HSK-A63 / HSK-A100
- **Chip conveyor**
- **Ergonomic machine design**

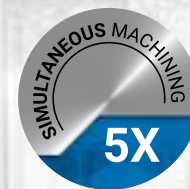
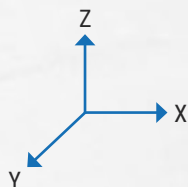

# EQUIPMENT & AUTOMATION

We look for the highest possible **quality and durability** when selecting our components. Our main goal is **to increase our customers' productivity** and to maintain it at all times. That is why we pay

COMPONENT MANUFACTURERS	
Axle drives	SIEMENS
Direct measuring system	HEIDENHAIN
Ball screws	PMI
Linear guides	HIWIN
Spindle / milling head / rotary table	CYTEC
Control	HEIDENHAIN / SIEMENS
Safety relay	PILZ

In addition to the standard equipment, we offer you a wide range of options for configuring the machines according to your needs. In addition to the options listed below, we are **also available for**



**Tool magazines:** Use our modular tool magazine technology for up to **320 tools!**

attention to **perfectly matched components** already during machine design, and select our suppliers carefully.



**customized technical solutions. Please contact us with your specific requests or with any questions you may have!**



**Automation Solutions:** In addition to standard solutions, such as **our 5-way pallet changer PW5-250 with a footprint of less than 4m<sup>2</sup>**, we are happy to develop an automation system tailored to your particular needs.

# TECHNICAL DATA

		MM 1000		MM 1000 XL	
		Milling	Mill-Turn	Milling	Mill-Turn
<b>WORKING AREA</b>					
Travel range X / Y / Z	mm	1,000 / 800 / 700		1,000 / 1,150 / 700	
Spindle nose distance - machine table (vertical)	mm	113 - 813			
Spindle nose distance - machine table (horizontal)	mm	50 - 750			
Rapid traverse X / Y / Z	m/min	40			
Acceleration X / Y / Z	m/s <sup>2</sup>	4			
Feed force	N	8,000			
<b>CONTROL</b>					
HEIDENHAIN TNC 640 (optional SIEMENS 840D)					
<b>B-AXIS SWIVEL MILLING HEAD (STANDARD)</b>					
Swivel range	°	-10 to +190			
Swivel speed	°/s	360 (60 rpm)			
<b>MAIN SPINDLE (STANDARD)</b>					
Power S1/S6	kW	27 / 32		34 / 43	
Torque S1/S6	Nm	130 / 170		170 / 220	
Speed, max.	rpm	12,000		12,000 / 10,000	
Tool taper		HSK-A63	HSK-T63	HSK-A100	HSK-T100
<b>ROTARY TABLE</b>					
Clamping surface	mm	Ø 1,000 x 800	Ø 900	Ø 1,000 / 800	Ø 900
Loading weight, max.	kg	2,000	1,000	2,000	1,000
Speed, max.	rpm	95	800	95	800
<b>ACCURACY ACCORDING TO VDI / DGQ 3441</b>					
Positioning accuracy X / Y / Z	mm	0.009			
Positioning accuracy B / C	"	±5			
Repeatability X / Y / Z	mm	0.007			
Repeatability B / C	"	±5			
<b>TOOL MAGAZINE (STANDARD)</b>					
No of tools		52		60	
No of tools (optional)		up to 320			
Tool weight, max.	kg	8		20	
Tool length, max.	mm	300		350	
Tool taper		HSK-A63	HSK-T63	HSK-A100	HSK-T100
<b>INSTALLATION DATA</b>					
Space requirements X / Y / Z	mm	5,000 / 5,300 / 3,500		5,000 / 5,800 / 3,500	
Weight	kg	15,000		15,500	
Total connection capacity	kVA	70			
Mains connection	V	3 x 400			
Compressed air supply	bar	6			

# MULTIMILL SERIES

The power pack with HSK-A100 and 525 Nm as standard.

## > MM 1600

The universal **5-axis machining center MM 1600** from our **MULTIMILL series** enables the best results in heavy-duty machining, thanks to its robust design. However, the high-precision torque drives also allow machining of filigree components. The machine can be configured as **Mill-Turn center**, thus offering an even wider range of machining options.

### Highlights of the standard version

- **HEIDENHAIN TNC 640**
- **5-axis simultaneous machining** thanks to G30 45° swivel milling head
- **Highly dynamic**, thanks to NC rotary table with torque drives and a **table size of Ø1,320 mm**
- **Direct position measuring systems** in all axes
- Powerful motor spindles with 8,000 rpm and **525 Nm** torque (S6)
- **Tool magazine with 60 pockets** HSK-A100
- **Chip conveyor**
- **Ergonomic** machine design

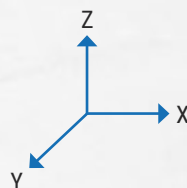
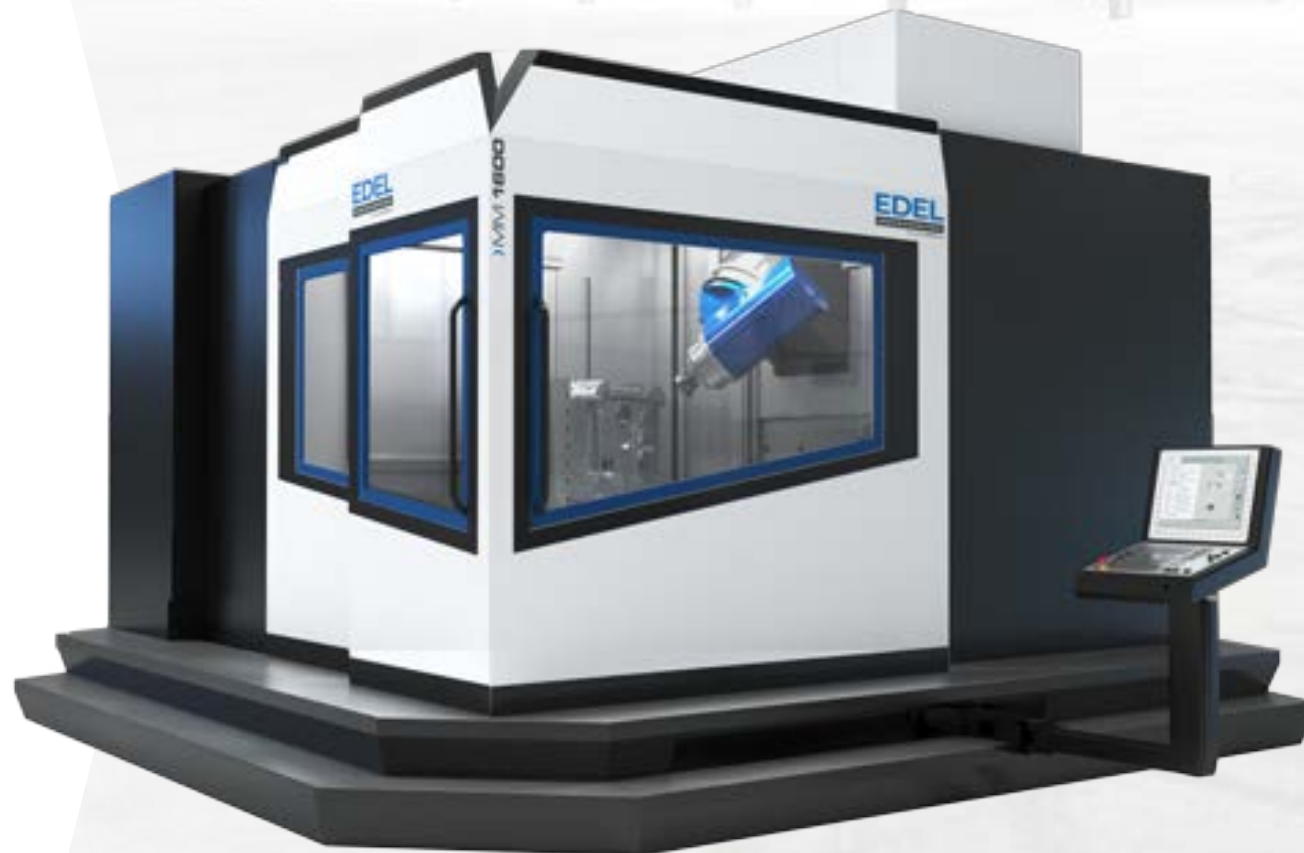
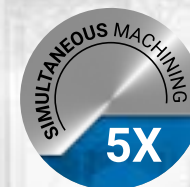



# EQUIPMENT & STABILITY

We look for the highest possible **quality and durability** when selecting our components. Our main goal is **to increase our customers' productivity** and to maintain it at all times. That is why we pay

attention to perfectly matched components already during machine design and select our suppliers carefully.

COMPONENTS MANUFACTURERS	
Axle drives	SIEMENS
Direct measuring system	HEIDENHAIN
Ball screws	HIWIN
Linear guides	SCHNEEBERGER
Spindle / milling head / rotary table	CYTEC
Control	HEIDENHAIN / SIEMENS
Safety relay	PILZ



A **mature machine concept** that ensures maximum stiffness and optimum machining results.

## Highlights

- 4-way guided X-carriage
- Max. workpiece weight: 4,000 kg
- Large workspace
- Mill-Turn technology optional

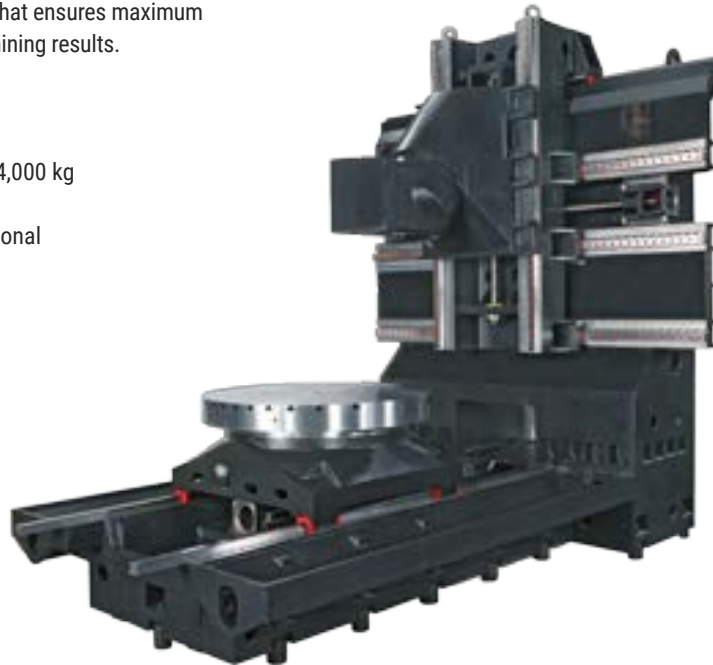

# TECHNICAL DATA

		Milling	Mill-Turn
<b>WORKING AREA</b>			
Travel range X / Y / Z	mm	1,620 / 1,260 / 1,050	
Spindle nose distance - machine table (vertical)	mm	200 - 1,250	
Spindle nose distance - machine table (horizontal)	mm	100 - 1,150	
Rapid traverse X / Y / Z	m/min	24	
Acceleration X / Y / Z	m/s <sup>2</sup>	3,5 / 3,2 / 3	
Feed force X / Y / Z	N	22,700 / 28,200 / 30,300	
<b>CONTROL</b>			
HEIDENHAIN TNC 640 (optional SIEMENS 840 D)			
<b>B-AXIS SWIVEL MILLING HEAD (STANDARD)</b>			
Swivel range	°	-10 to +190	
Swivel speed	°/s	360 (60 rpm)	
<b>MAIN SPINDLE (STANDARD)</b>			
Power S1/S6	kW	42 / 55	
Torque S1/S6	Nm	400 / 525	
Speed, max.	rpm	8,000	
Tool taper		HSK-A100	HSK-T100
<b>ROTARY TABLE C-AXIS</b>			
Clamping surface	mm	Ø 1.320	
Loading weight, max.	kg	4,000	2,000
Speed, max.	rpm	100	450
<b>ACCURACY ACCORDING TO VDI / DGQ 3441</b>			
Positioning accuracy X / Y / Z	mm	0.009	
Positioning accuracy B / C	"	± 2.5	
Repeatability X / Y / Z	mm	0.007	
Repeatability B / C	"	± 2.5	
<b>TOOL MAGAZINE (STANDARD)</b>			
No of tools		60	
No of tools (optional)		up to 320	
Tool weight, max.	kg	20	
Tool length, max.	mm	350	
Tool taper		HSK-A100	HSK-T100
<b>INSTALLATION DATA</b>			
Space requirements X / Y / Z	mm	6,600 / 5,950 / 4,250	
Weight	kg	26,000	
Total connection capacity	kVA	140	
Mains connection	V	3 x 400 / 50 Hz	
Compressed air supply	bar	6	

# ROTAMILL SERIES

5/6-axis gantry machining center with rotary table.

› RM 2213

› RM 2216

The portal machining centers of the **ROTAMILL series** have an established **gantry design**. Perfect precision with the highest dynamics makes these machines true all-rounders. Large travel paths allow the machining of large and heavy workpieces with **the highest demands on surface quality and accuracy**. The 5-axis simultaneous machining achieved by the 2-axis fork-type milling head is supplemented with the 6th axis positioned rotary or swivel table. **A compound machining process** for components, completed in a single clamping, ensures enormous time savings during production.

## Highlights of the standard version

- HEIDENHAIN TNC 640
- **5-axis multiprocessing** thanks to M21 fork-type milling head
- **Highly dynamic** thanks to NC rotary table with torque drives and a **table size of Ø1,800 mm**
- Max. table load: **6,000 kg**
- **Direct position measuring systems** in all axes
- High-speed HSK-A63 motor spindle with **20,000 rpm**
- Rapid traverse: **50 m/min**
- **Tool magazine with 48 pockets** HSK-A63/HSK-A100
- **Chip conveyor**
- **Ergonomic** machine design

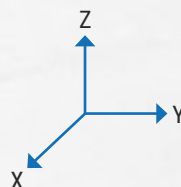
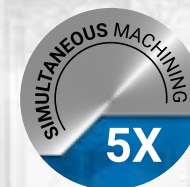

# 3 TECHNOLOGIES IN ONE MACHINE

## Roughing, finishing & turning

The machines of the ROTAMILL series become integral production centers with the optional **automatic head change station**. A total of **three M21 size milling heads can be accommodated within the machine**. Changing the head takes less than a

minute. This enables you to optimally meet the requirements of the respective processing. Our tool magazines can be adapted accordingly and are also available as dual systems (e.g. HSK-T100 and HSK-A63).



A sophisticated machine concept ensures maximum **stiffness** and **optimum machining results**.

### Highlights of the machine concept

- **Highly dynamic rotary axes** in milling head and rotary table, thanks to torque drives
- **Vibration damping**, thanks to the machine base filled with polymer concrete
- Optimal accessibility and loading
- **High thermal stability**, thanks to effective cooling technology
- **Size 63** ball screws
- Roller-guided linear axes **Size 55**

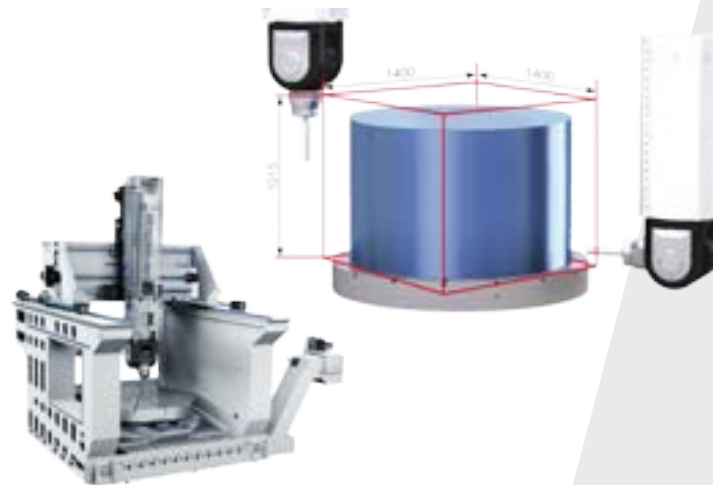

		RM 2213   RM 2216	
		Milling	Mill-Turn
<b>WORKING AREA</b>			
Travel range X / Y / Z	mm	2,200 / 1,300   1,600 / 1,200	
Spindle nose distance - machine table (vertical)	mm	1,300   1,600	
Spindle nose distance - machine table (horizontal)	mm	1,200	
Rapid traverse X / Y / Z	m/min	50 / 50 / 50	
Acceleration X / Y / Z	m/s <sup>2</sup>	4	
Feed force	N	10,000	
<b>PORTAL PASSAGE</b>			
Width Y	mm	1,900   2,200	
Height Z	mm	1,390 / optional: 1,560	
<b>CONTROL</b>			
HEIDENHAIN TNC 640 (optional SIEMENS 840D)			
<b>2-AXIS MILLING HEAD M21 FORK A- / C-AXES STANDARD</b>			
Swivel range	°	± 110 / ± 360	
Swivel speed	°/s	360 / 360	
<b>MAIN SPINDLE (STANDARD)</b>			
Power S1/S6	kW	28 / 35	27 / 32
Torque, max. S1/S6	Nm	90 / 113	130 / 170
Speed, max.	rpm	20,000	12,000
Tool taper		HSK-A63	HSK-T63
<b>ROTARY TABLE (STANDARD)</b>			
Clamping surface	mm	Ø 1,800 (optional Ø 1,200, Ø 1,500)	
Loading weight, max.	kg	6,000	2,000
Speed, max.	rpm	40	300
<b>ACCURACY ACCORDING TO VDI / DGQ 3441</b>			
Positioning accuracy X / Y / Z	mm	0.009	
Positioning accuracy A / C	"	±5	
Positioning accuracy C2	"	± 2.5	
Repeatability X / Y / Z	mm	0.007	
Repeatability A / C	"	±5	
Repeatability C2	"	± 2.5	
<b>TOOL MAGAZINE (STANDARD)</b>			
No of tools		48/64 HSK-A63 - 39/52 HSK-A100 - optional 320	48/64 HSK-T63 - 39/52 HSK-T100 - optional 320
Tool weight, max.	kg	8 HSK-A63 - 15 HSK-A100	8 HSK-T63 - 15 HSK-T100
Tool length, max.	mm	300 HSK-A/T63, 350 HSK-A/T100	
Tool diameter / interface	mm	Ø 105/130 / HSK-A63 - Ø125/175 / HSK-A100	Ø 105/130 / HSK-T63 - Ø125/175 / HSK-T100
<b>INSTALLATION DATA</b>			
Space requirements X / Y / Z	mm	6,780 / 6,550   6,900 / 5,150	
Weight	kg	36,000	
Total connection capacity	kVA	125	
Mains connection	V	3 x 400 / 50 Hz	
Compressed air supply	bar	6	

# TABLEMILL SERIES

5-axis gantry machining centers.

› TM 2413

› TM 3620

› TM 4820

› TM 4827

The portal machining centers of the TABLEMILL series have an established **gantry design**. **Perfect precision** with strong dynamics makes these machines real all-rounders. Large travel paths allow the machining of large and heavy workpieces with **the highest demands on surface quality and accuracy**. The **5-axis simultaneous machining** achieved by the 2-axis fork-type milling head makes extremely high productivity possible.

#### Highlights of the standard version

- HEIDENHAIN TNC 640
- **5-axis simultaneous machining** thanks to M21 fork-type milling head with torque drive technology
- High workpiece weights
- **Direct position measuring systems** in all axes
- High-speed **HSK-A63** motor spindle with **20,000 rpm**
- Rapid traverse: **50 m/min**
- **Tool magazine with 48 pockets** HSK-A63/HSK-A100
- **Chip conveyor**
- **Ergonomic** machine design

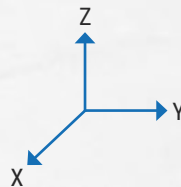



# INDIVIDUAL SPECIFICATIONS

## Roughing, finishing & grinding on one machine

The machines of the TABLEMILL become integrated production centers with the optional **automatic head change station**. A total of **three M21 size milling heads** can be accommodated within the machine. Changing the head takes less than a

minute. This enables you to optimally meet the requirements of the respective processing. Our tool magazines can be adapted accordingly and are also available as dual systems (e.g. HSK-A100 and HSK-A63).



## Individual tabletop configurations

Due to **the gantry design** and the rigid machine table, the machines of the TABLEMILL series are characterized by their enormous flexural stiffness. **The table tops of the machines can be individually**

**adjusted** – to allow you to use already existing clamping devices or zero point clamping systems. Furthermore, it is possible to install additional axes in the machine in the form of mounted tables.



# TECHNICAL DATA

WORKING AREA		
Travel range X	mm	2,400   3,600   4,800
Travel range Y	mm	1,360   2,035   2,710
Travel range Z	mm	1,200   1,400 (optional)
Rapid traverse X / Y / Z	m/min	50 / 50 / 50
Acceleration X / Y / Z	m/s <sup>2</sup>	4
Feed force	N	10,000
PORTAL PASSAGE		
Width Y	mm	2,030   2,750   3,470
Height Z	mm	1,450   1,650 (optional)
CONTROL		
HEIDENHAIN TNC 640 (optional SIEMENS 840D)		
2-AXIS MILLING HEAD M21 FORK A- / C-AXIS (STANDARD)		
Swivel range	°	±110 / ± 360
Swivel speed	°/s	360 / 360
MAIN SPINDLE (STANDARD)		
Power S1/S6	kW	28 / 35
Torque, max. S1/S6	Nm	90 / 113
Speed, max.	rpm	20,000
Tool taper		HSK-A63
ACCURACY ACCORDING TO VDI / DGQ 3441		
Positioning accuracy X / Y / Z	mm	0.009
Positioning accuracy A / C	"	±5
Repeatability X / Y / Z	mm	0.007
Repeatability A / C	"	±5
TOOL MAGAZINE (STANDARD)		
No of tools		48/64 HSK-A63 - 39/52 HSK-A100 - optional to 320
Tool weight, max.	kg	8 HSK-A63 - 15 HSK-A100
Tool length, max.	mm	300 HSK-A63, 350 HSK-A100
Tool diameter / taper	mm	Ø 105/130 / HSK-A63 - Ø125/175 / HSK-A100
INSTALLATION DATA		
Space requirements X / Y / Z	mm	7,060 - 9,940 / 6,580 - 7,920 / 4,500 - 5,700
Total weight	kg	32,000 - 38,000
Total connection capacity	kVA	110
Mains connection	V	3 x 400 / 50 Hz
Compressed air supply	bar	6

# CYPORT SERIES

Portal milling machines with a travel path of up to 8 meters.

> CP 3020   > CP 5030  
 > CP 4030   > CP 7030  
 > CP 5030   > CP 8030

The machines of the **CYPORT series** are impressive due to their sheer size and an **unbeatable ratio of workspace to footprint**. Components with a length of up to 11 meters can be machined on our **standard machines with a maximum travel path of 8,000 mm**. We are able to produce larger machines at the customer's special request. The **double portal with two-sided gantry drive** version is convincing with regard to **stiffness and stability**. By selecting 2-axis fork-type milling heads, the standard version of the machines is configured **for 5-axis simultaneous machining**.

#### Highlights of the standard version

- **HEIDENHAIN TNC 640**
- **5-axis simultaneous machining**, thanks to M21 fork-type milling head with torque drive technology
- Workpiece weights of up to **98 tons**
- **Direct position measuring systems** in all axes
- High-speed HSK-A63 motor spindle with **20,000 rpm**
- Rapid traverse: **30 m/min**
- **Tool magazine with 48 pockets HSK-A63**
- **Chip conveyor**
- **Best accessibility** for loading and setting up the machine

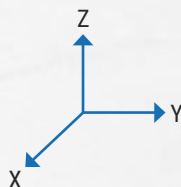
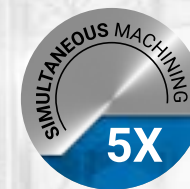

# HUGE RANGE OF PARTS DUE TO SHEER SIZE

## Optional machine extensions

In addition to the standard, versions we offer a wide range of options for **configuring the machine to your exact requirements**. The spectrum extends

from **tool magazines with up to 320 slots**, through automatic head change stations and on to (several) additional axes.



## Stability and space

Only two of the attributes with which the machines of the CYPOR series can score points. The high-stiffness double portal offers the necessary

quality even when roughing. The portal moves on two linear guides on both sides. While being driven by robust ball screws.



## TECHNICAL DATA

WORKING AREA		
Travel range X	mm	3,000   4,000   5,000   6,000   7,000   8,000
Travel range Y	mm	2,000   3,000
Travel range Z	mm	1,000   1,200 (optional)
Rapid traverse X / Y / Z	m/min	30 / 30 / 25
Acceleration X / Y / Z	m/s <sup>2</sup>	3
Feed force	N	10,000
PORTAL PASSAGE		
Width Y	mm	2,276   3,276
Height Z	mm	1,205   1,405 (optional)
CONTROL		
HEIDENHAIN TNC 640 (optional SIEMENS 840D)		
2-AXIS MILLING HEAD M21 FORK A- / C-AXIS (STANDARD)		
Swivel range	°	± 110 / ± 360
Swivel speed	°/s	360 / 360
MAIN SPINDLE (STANDARD)		
Power S1/S6	kW	28 / 35
Torque, max. S1/S6	Nm	90 / 113
Speed, max.	rpm	20,000
Tool taper		HSK-A63
ACCURACY ACCORDING TO VDI / DGQ 3441		
Positioning accuracy X / Y / Z	mm	0.009
Positioning accuracy A / C	"	±5
Repeatability X / Y / Z	mm	0.007
Repeatability A / C	"	±5
TOOL MAGAZINE (STANDARD)		
No of tools		48 - optional up to 320
Tool weight, max.	kg	8 (HSK-A63) / 15 (HSK-A100)
Tool length, max.	mm	300 HSK-A63, 350 HSK-A100
Tool diameter / taper		Ø 105/130 / HSK-A63 - Ø 125/175 / HSK-A100
INSTALLATION DATA		
Space requirements X / Y / Z	mm	4,950 - 12,800 / 4,400 - 7,700 / 5,020 - 5,650
Total weight	kg	23,000 - 56,000
Total connection capacity	kVA	55
Mains connection	V	3 x 400 / 50 Hz
Compressed air supply	bar	6

# AUTOMATION

From robot to pallet system.

The cooperation of EDEL Werkzeugmaschinen GmbH with DEPO Werkzeugmaschinen GmbH under the umbrella of GMTG gives access to a **huge range of automation options** for our customers, individually tailored to their respective requirements and profiles.

This is how we realize simple **workpiece handling systems using robots** as well as highly complex **pallet storage systems** with a number of pallets, all to customer requirements.

Example on the right:

## CM 400 with PW40-180

### Highlights:

- Compact footprint
- Best accessibility
- 40 pallets of size 250x250 mm
- Max. workpiece size: 250x250x250 mm
- Max. workpiece weight: 180 kg
- Total system space requirement: 21 m<sup>2</sup>





# AUTOMATION

## MM 1000 XL with PW5-250

Example on the right:

### Highlights of PW5-250

- Compact footprint of only 4 m<sup>2</sup>
- Best accessibility
- 5 pallets of size 400x400 mm
- Max. workpiece size: 400x400x400 mm
- Max. workpiece weight: 250 kg



# EQUIPMENT & OPTIONS

**Added value** – through a wide range of options.

Benefit from increased user value by equipping the machine from a wide selection of available individual equipment options.



Laser measuring system



Clear Vision



Pallet changer

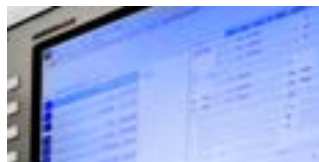

Kinematics measuring cycle

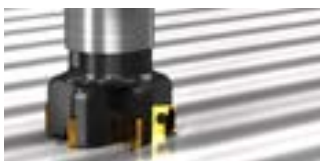

Collision checking



Automatic head change



Suction unit



Up to 320 tools



# DEPO

WERKZEUGMASCHINEN

Part of the GMTGroup

## PRODUCT PORTFOLIO

### State-of-the-art machining centers

DEPO's horizontal and vertical 5-axis machining centers are characterized by an extremely high degree of modularity. The resulting flexibility in the machine specification creates great added value for our customers.

We equip the machines together with you, exactly to your requirements, and never lose sight of the most economical solution.

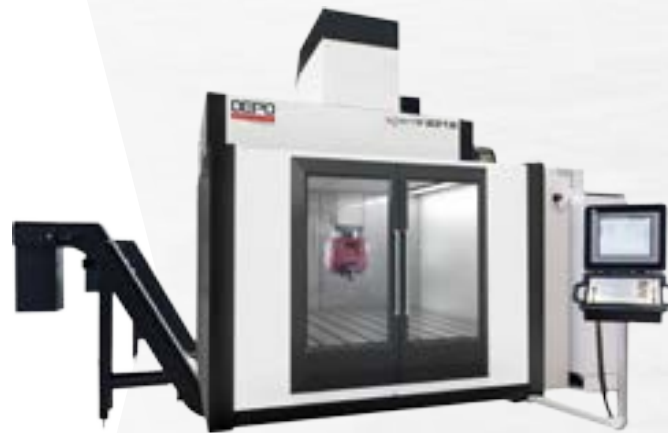

**XpertV series**  
Vertical 5-axis machining centers  
in gantry design



**XpertV 3520 HD**  
Vertical 5-axis machining centers in a gantry design for the most difficult machining tasks and a rotary table integrated into the tabletop with a load of more than 20,000 kg!



**XpertK series**  
Horizontal 5-axis machining centers

# THERE FOR YOU WORLDWIDE.



 Sales & Services

You will find us in Pliezhausen, Germany | Marienfeld, Germany | Jülich, Germany | Weißenfels, Germany | Dornhan, Germany | Birmingham, England | Wetzikon, Switzerland | Linz, Austria | Den Bosch, Netherlands | Reims, France | Porto, Portugal | Budapest, Hungary | Bursa, Turkey | Anaheim, USA | Port Saint Lucie, USA | Monterrey, Mexico | Bangalore, India | Mumbai, India | Chennai, India | Shanghai, China | Peking, China | Shenzhen, China | Seoul, Korea

» All personal contact details available at [www.gmt-group.de](http://www.gmt-group.de)

# EDEL

WERKZEUGMASCHINEN

Part of the GMTGroup

## CONTACT

### EDEL Werkzeugmaschinen GmbH

Wilhelm-Schickard-Str. 7  
DE-72124 Pliezhausen

Phone +49 180 6 40 41 40

(for calling costs please contact your provider)

We would be delighted to advise you personally. **Contact us now!**



#### SERVICE

[service@gmt-group.de](mailto:service@gmt-group.de)

#### SALES

[sales@gmt-group.de](mailto:sales@gmt-group.de)

#### HEADQUARTERS

[info@gmt-group.de](mailto:info@gmt-group.de)



#### SERVICE-HOTLINE

+49 180 6 40 41 40

(for calling costs please contact your provider)

EDEL\_Matrix\_02 | 04/2022 | en

We reserve the right to make technical modifications. The machines shown here may include options, accessories and control variants.